

Easy measuring, reliable monitoring and flexible planning - the EMR, ETR and EMT relays





The measuring and monitoring of industrial applications made simple - with the EMR6



With the new EMR6 devices, the existing range of the ETR4 / EMR5 measuring relays is being updated to reflect the latest technology. The EMR6 series will seamlessly replace and even expand the existing product range.



The EMR6 measuring and monitoring relays are designed for a wide range of switchgear applications. Thanks to their ability to monitor overloads, power fluctuations, phase sequences, machine temperatures and fill levels, the EMR6 relays protect machines and plants and help to prevent unscheduled downtime in production processes.



The device has been approved for global use and can therefore be used to monitor plants reliably and seamlessly, anywhere in the world.



The EMR6 is available in the following versions:

- Phase sequence relay
- Phase imbalance monitoring relay
- Multi-function relay
- Current monitoring relay
- Voltage monitoring relay
- Insulation-monitoring relay
- Level relay
- Temperature relay



The next generation

With the new EMR6 product line, Eaton's existing range of EMR4 / EMR5 measuring relays is being updated to reflect the latest technology.

The new enclosure design of the EMR6 is based on that of our existing relay portfolio (EMT6 / ETR4). The EMR6 completely replaces the existing product range, consisting of the EMR4 and EMR5 devices.

In addition to replacing the existing series, the launch of nine new relay types with additional functionalities (for monitoring current, voltage and temperature) will expand Eaton's product range to 35 devices.

At a glance

- ✓ Suitable for universal use, thanks to multi-voltage power supplies
- ✓ Reduced machine downtime and early detection of possible failures during operation
- ✓ The universal, multi-functional devices reduce inventory costs and save time during the equipment selection process
- ✓ An expanded product range with additional functionalities
- ✓ Relays for monitoring machine temperatures



The EMR4 / EMR5 series will be fully replaced by the end of June 2019.

Name	Article no.	Will replace	Name	Article no.
EMR6-F500-G-1	184789	1:1 Replacement	EMR4-F500-2	221784
EMR6-I1-A-1	184790	1:1 Replacement	EMR4-I1-1-A	106942
EMR6-I15-A-1	184754	1:1 Replacement	EMR4-I15-1-A	106943
EMR6-I15-B-1	184755	1:1 Replacement	EMR4-I15-1-B	106944
EMR6-N1000-N-1	184756	1:1 Replacement	EMR4-N100-1-B	221789
EMR6-N1000-A-1	184757	Consolidation of two types	EMR4-N500-2-A	221791
			EMR4-N500-2-B	221790
EMR6-N100-N-1	184758	1:1 Replacement	EMR4-N080-1-B	134232
EMR6-PH22	184759	Suitable only for EMR6	EMR4-PH22	221794
EMR6-PH45	184760	Suitable only for EMR6	EMR4-PH45	221795
EMR6-A300-C-1	184761	1:1 Replacement	EMR5-A300-1-C	134230
EMR6-A500-D-1	184762	1:1 Replacement	EMR5-A400-1	134222
EMR6-AW300-C-1	184763	1:1 Replacement	EMR5-AW300-1-C	134223
EMR6-AW500-D-1	184764	1:1 Replacement	EMR5-AW500-1-D	134224
EMR6-AWM580-H-1	184765	1:1 Replacement	EMR5-AWM580-2	134235
EMR6-AWM720-I-1	184766	1:1 Replacement	EMR5-AWM720-2	134236
EMR6-AWM820-J-1	184767	1:1 Replacement	EMR5-AWM820-2	134237
EMR6-AWN170-E-1	184768	1:1 Replacement	EMR5-AWN170-1-E	134225
EMR6-AWN280-K-1	184769	1:1 Replacement	EMR5-AWN280-1	134233
EMR6-AWN280-D-1	184770	1:1 Replacement	EMR5-AWN280-1-F	134226
EMR6-AWN500-D-1	184771	1:1 Replacement	EMR5-AWN500-1	134234
EMR6-R250-A-1	184772	1:1 Replacement	EMR5-R250-1-A	153442
EMR6-R400-A-1	184773	1:1 Replacement	EMR5-R400-1-A	153443
EMR6-R400-A-2	184774	1:1 Replacement	EMR5-R400-2-A	153444
EMR6-RC690	184775	1:1 Replacement	EMR5-RC690	153445
EMR6-W300-C-1	184776	1:1 Replacement	EMR5-W300-1-C	134227
EMR6-W380-L-1	184777	1:1 Replacement	EMR5-W380-1	134228
EMR6-W400-M-1	184778	1:1 Replacement	EMR5-W400-1	134229
EMR6-W500-D-1	184779	1:1 Replacement	EMR5-W500-1-D	134221
Extension of the product range				
EMR6-IM1-A-1	184780	NEW		
EMR6-IM15-A-1	184781	NEW		
EMR6-IF1-A-1	184782	NEW		
EMR6-IF15-A-1	184783	NEW		
EMR6-VM600-A-1	184784	NEW		
EMR6-VF600-A-1	184785	NEW		
EMR6-T50-A-1	184786	NEW		
EMR6-T100-A-1	184787	NEW		
EMR6-T200-A-1	184788	NEW		



Three-phase measuring relays

For the monitoring of...

- Phase imbalances
- Voltage
 - Over-voltage and under-voltage
 - Voltage windows
- Phase failure
- Phase sequences
- Cable breaks

Features:

- Adjustable ON- and OFF-delay
- Power supply via the measuring circuit

Applications:

- Monitoring the operating direction of conveyor belt motors
- Detection of overloads and phase imbalances in voltage-sensitive machines and plants
- Activation of emergency or backup power supplies in case of under-voltage or phase failure
- Monitoring the rated voltage of portable / mobile three-phase loads

Protection of...

- Three-phase motors against phase failure and phase change
- Transformers through the detection of asymmetric loads
- Personnel and equipment during rotation reversal
- Consumer loads against destruction in the case of unstable power supplies
- Motors against destruction in the case of phase imbalance and phase failure

Single-phase measuring relays

For the monitoring of...

- Voltage
 - Over-voltage and under-voltage
 - Voltage windows
- Currents
 - Over-current and under-current
 - Current windows

Features:

- Three or four measurement ranges in one device
- Power supply via the measuring circuit

Applications:

- Measuring the current consumption of motors, e.g. that of pumps, elevators or cranes
- Monitoring of electrical systems, e.g. lighting circuits, heating circuits or charging stations
- Monitoring the supply minimum for emergency lighting systems
- Detection of overloads in DC motors
- Monitoring of screw conveyors, e.g. those used in wastewater treatment plants
- Detection of overload situations in hoisting gear and handling equipment
- Monitoring of locking devices or of impacts on end stops

Protection against...

- Voltage drops in sensitive or essential systems
- Damage to or destruction of individual loads in the case of overload or over-current
- Deviations from standard operating sequences

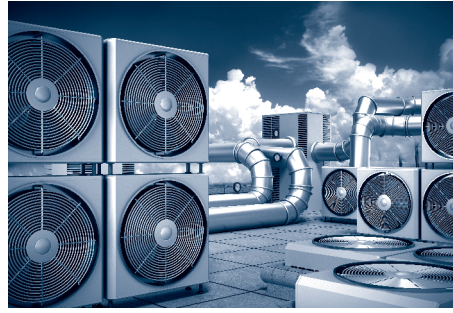

Level relays

For the monitoring of...

- Fill levels
- Mixing ratios

Features:

- Adjustable ON- and OFF-delay to prevent the device from triggering due to temporary fill-level fluctuations

Applications:

- Measuring of fill levels in production tanks
- Monitoring of mixing ratios of conductive liquids
- Monitoring of overflow or dry-running in liquid storage tanks
- Monitoring of applications that rely on filling and draining

Functionality:

- Fill-level monitoring relays report the fill levels of conductive liquids or any changes in electrical resistance.
- In the case of conductive fill-level monitoring, the relays detect to what extent the sensor rods are covered by water. The resistance changes if the sensors are wetted when immersed in the medium.

Temperature relays

For the monitoring of...

- Temperatures in machine or plant environments
 - Temperatures that are too high or too low
 - Temperature windows

Features:

- Adjustable hysteresis, 2 - 20 %
- Short-circuit and open-circuit monitoring

Applications:

- Monitoring the operating temperatures of machines and plants
- Analyzing the data provided by the PT100 temperature sensors
- Control of heating and cooling units in order to keep the temperature within a pre-defined range

Functionality:

- To detect, report and regulate the temperature, the PT100 sensors are immersed in the medium, which can be solid, liquid or gaseous.
- The relay then processes the feeler data to check if temperatures exceed or undershoot the pre-defined parameters.
- In addition, output relays make it possible to further regulate the temperature.

Insulation-monitoring relays

For the monitoring of...

- Insulation resistance in ungrounded it networks
- Cable breaks

Features:

- Test or reset function either via a button on the device, or via the control input
- Configurable fault memory / memory function

Applications:

- Monitoring of renewable energy systems such as wind or solar facilities
- Monitoring of ship networks
- Monitoring the power supplies of crane systems

Functionality:

- To this end, the relay measures the insulation resistance between the network conductors and the signal ground. If the value falls below the pre-defined adjustable threshold, the output relay will drop off.



Reliable protection against over-temperature - EMT6 thermistor overload relays for machine protection



The EMT6 thermistor relay protects machines against over-temperature caused by heavy starting duties, braking, under-voltage, over-voltage, and high switching frequencies. The temperature is monitored by means of a thermistor directly at the motor winding. In the event of over-temperature, the corresponding signal is relayed to the EMT6 unit. Once the unit receives the signal, it trips, and the fault signal can be reliably detected in the corresponding control cabinet.

The EMT6 is also suitable for monitoring the temperatures of motor bearings, gearboxes, oils and coolants. In addition, depending on the model, additional functionalities are available, including zero-voltage protection, short-circuit monitoring, and the ability to choose between automatic and manual switch-off.

All relays have UL/CSA approval and are suitable for global use in line with IEC/EN standards.

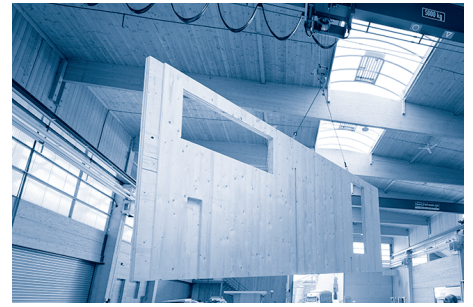
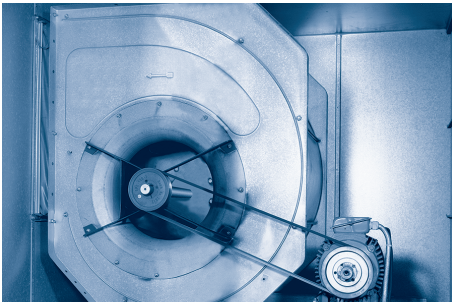

Function tests

The functionality of the relay needs to be tested on a regular basis, both during commissioning and maintenance. To make this as easy as possible, all EMT6 models feature an integrated test button that can be used to simulate an error condition.

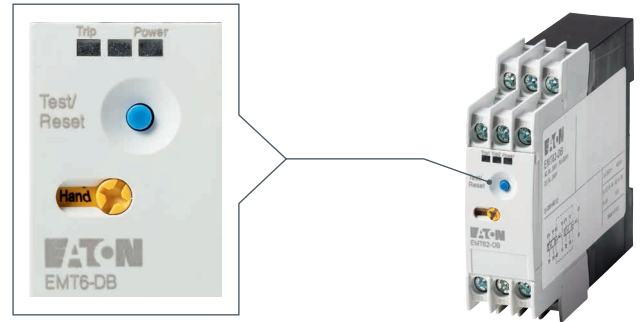

Sample application: Tripping in case of over-temperature due to overload

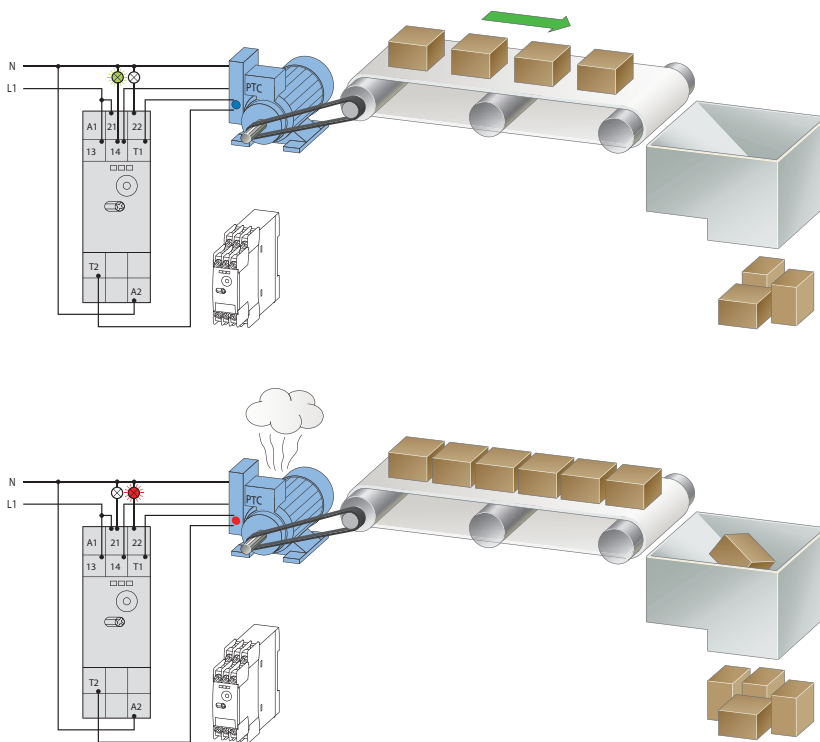

Two sensor circuits for enhanced functionality

The EMT6 product line also includes the option to install two separate sensor circuits. These two-circuit models make it possible to monitor the temperature at two different points – either on a single motor or on two separate motors – in a cost-effective and space-saving manner.

This not only means that multiple motors can be monitored simultaneously with a single device, but also that these devices can be used to implement a cost-effective early warning system, by monitoring two sensor circuits with different triggering temperatures.



Flexible planning thanks to a broad range of possible solutions – the ETR4 and ETR2 timing relays



The design of the ETR4 timing relays is based on that of our measuring and monitoring relays and our safety relays. As a result, they save space inside the control cabinet and lend a uniform design appearance to your entire system. The ETR2 is a compact timing relay specifically for use in installation cabinets.

Two supply voltages are available: a multi-voltage model with 24 - 240 V AC / V DC, and a single-voltage model with 400 V AC. This reduces inventory costs while enhancing flexibility. Depending on the application at hand, you can choose between single-function and multi-function relays. The timing relays cover a total of 10 different functions.

All relays have UL/CSA approval and are suitable for global use in line with DIN EN 61812-1.



Precise settings along a wide time spectrum

Whether you are dealing with short signal extensions or extremely long processes: our multi-range time delay relays allow you to choose the right interval, from 0.05 seconds to 100 hours. First, a time range has to be selected, using the "Range" indicator. The specific interval can then be set using the "Time" indicator. This way, the time is set directly on the device, so that the scale shows the "actual" time.

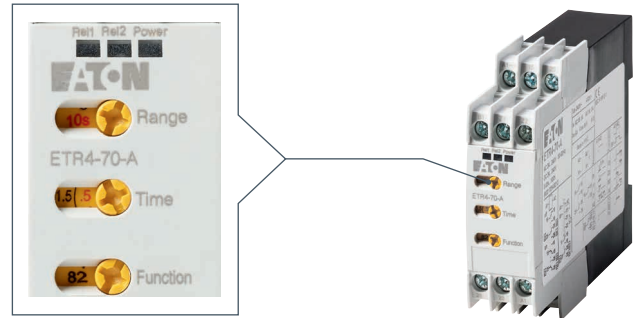

Sample application: Coordinated timing

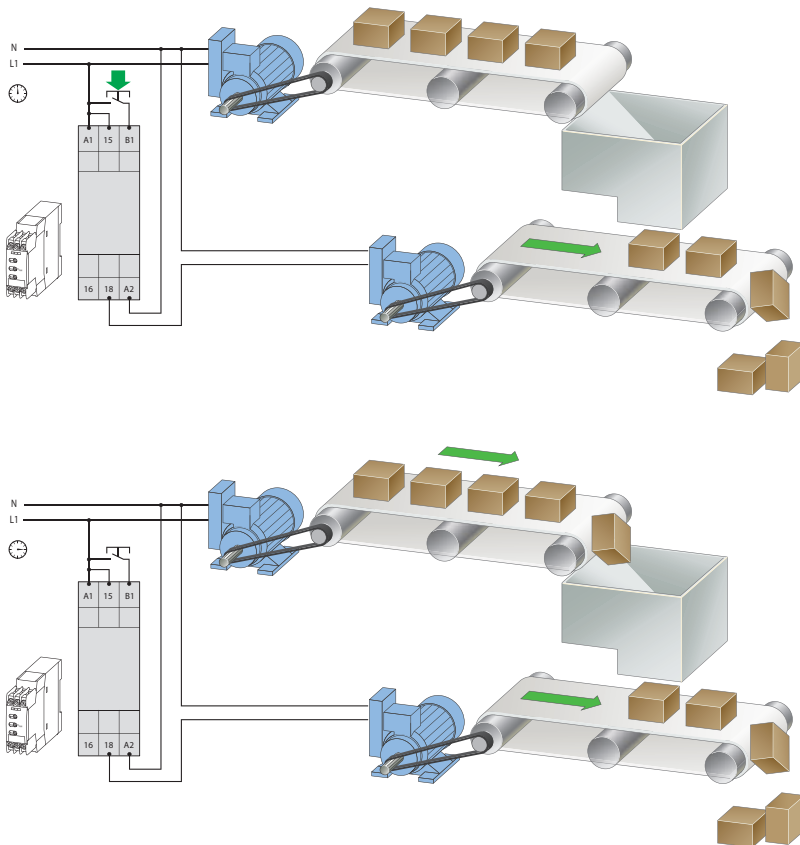









Universal applications

Whether your application involves conveyor belts, fan controls, or escalator control systems – the ETR4 timing relays offer maximum reliability across a broad range of applications. In fact, Eaton's ETR4 devices are the ideal choice for any application that requires reliable switching with highly precise time delays.



With their sleek design and wide voltage range, they are also the perfect option for manufacturers of control cabinets, switchgear systems, or control systems.

Moreover, their broad range of up to 10 functions (in case of the multi-function models) ensures that all important time sequences can be covered by a single device, thereby minimizing inventory even where applications vary.

EMR6 measuring and monitoring relays

Monitoring of		Phase sequence relay	Phase failure	Imbalance	Overvoltage	Undervoltage	Neutral cable break	Monitoring voltage per phase	Supply voltage	Part no. Article no.
Phase sequence relay 		X	X	-	-	-	-	200 - 500 V AC 50/60 Hz	200 - 500 V AC 50/60 Hz	EMR6-F500-G-1 184789
Phase imbalance monitoring relay 		X	X	X	-	-	-	160 - 300 V AC 50/60 Hz	160 - 300 V AC 50/60 Hz	EMR6-A300-C-1 184761
		X	X	X	-	-	-	300 - 500 V AC 50/60 Hz	300 - 500 V AC 50/60 Hz	EMR6-A500-D-1 184762
Multifunctional phase monitoring relay   	On- and Off-delayed	X	X	-	X	X	-	160 - 300 V AC 50/60 Hz	160 - 300 V AC 50/60 Hz	EMR6-W300-C-1 184776
	On- and Off-delayed	X	X	-	X	X	-	300 - 500 V AC 50/60 Hz	300 - 500 V AC 50/60 Hz	EMR6-W500-D-1 184779
	On- and Off-delayed	X	X	-	X	X	-	380 V AC 50/60 Hz	380 V AC 50/60 Hz	EMR6-W380-L-1 184777
	On- and Off-delayed	X	X	-	X	X	-	400 V AC 50/60 Hz	400 V AC 50/60 Hz	EMR6-W400-M-1 184778
		X	X	X	X	X	-	160 - 300 V AC 50/60 Hz	160 - 300 V AC 50/60 Hz	EMR6-AW300-C-1 184763
		X	X	X	X	X	-	300 - 500 V AC 50/60 Hz	300 - 500 V AC 50/60 Hz	EMR6-AW500-D-1 184764
		X	X	X	X	X	X	90 - 170 V AC 50/60 Hz	90 - 170 V AC 50/60 Hz	EMR6-AWN170-D-1 184768
		X	X	X	X	X	X	180 - 280 V AC 50/60 Hz	180 - 280 V AC 50/60 Hz	EMR6-AWN280-D-1 184770
	Automatic phase sequence correction	X	X	X	X	X	X	180 - 280 V AC 50/60/400 Hz	180 - 280 V AC 50/60/400 Hz	EMR6-AWN280-K-1 184769
		X	X	X	X	X	X	300 - 500 V AC 50/60 Hz	300 - 500 V AC 50/60 Hz	EMR6-AWN500-D-1 184771
	Automatic phase sequence correction	X	X	X	X	X	X	350 - 580 V AC 50/60 Hz	350 - 580 V AC 50/60 Hz	EMR6-AWM580-H-1 184765
	Automatic phase sequence correction	X	X	X	X	X	X	450 - 720 V AC 50/60 Hz	450 - 720 V AC 50/60 Hz	EMR6-AWM720-I-1 184766
Automatic phase sequence correction	X	X	X	X	X	X	530 - 820 V AC 50/60 Hz	530 - 820 V AC 50/60 Hz	EMR6-AWM820-J-1 184767	
Voltage monitoring relay 	Measuring range 3-30, 6-60, 30-300, 60-600 V On-delayed	-	-	-	X	X	-	Single phase	24 - 240 V 50/60 Hz AC/DC	EMR6-VM600-A-1 184784
	Measuring range 3-30, 6-60, 30-300, 60-600 V On-delayed	-	-	-	X	X	-	Single phase	24 - 240 V 50/60 Hz AC/DC	EMR6-VF600-A-1 184785
Current monitoring relay  	Measuring range 3-30 mA; 10-100 mA; 0.1-1 A							Single phase	24 - 240 V 50/60 Hz AC/DC	EMR6-I1-A-1 184790
	Measuring range 0.3-1.5 A; 1-5 A; 3-15 A							Single phase	24 - 240 V 50/60 Hz AC/DC	EMR6-I15-A-1 184754
	Measuring range 0.3-1.5 A; 1-5 A; 3-15 A							Single phase	220 - 240 V 50/60Hz AC	EMR6-I15-B-1 184755
	Measuring range 3-30 mA; 10-100 mA; 0.1-1 A							Single phase	24 - 240 V 50/60 Hz AC/DC	EMR6-IM1-A-1 184780
	Measuring range 0.3-1.5 A; 1-5 A; 3-15 A							Single phase	24 - 240 V 50/60 Hz AC/DC	EMR6-IM15-A-1 184781
	Measuring range 3-30 mA; 10-100 mA; 0.1-1 A							Single phase	24 - 240 V 50/60 Hz AC/DC	EMR6-IF1-A-1 184782
	Measuring range 0.3-1.5 A; 1-5 A; 3-15 A							Single phase	24 - 240 V 50/60 Hz AC/DC	EMR6-IF15-A-1 184783
Level monitoring relay 	On- and Off-delayed							Response value 0.1 - 1000 kOhm	110 - 130 V AC. 50/60Hz 220 - 240 V AC. 50/60Hz	EMR6-N1000-N-1 184756
	On- and Off-delayed							Response value 0.1 - 1000 kOhm	24 - 240 V AC, 50/60 Hz 24 - 240 V DC	EMR6-N1000-A-1 184757
	On- and Off-delayed							Response value 5 - 100 kOhm	110 - 130 V AC. 50/60Hz 220 - 240 V AC. 50/60Hz	EMR6-N100-N-1 184758

EMR6 measuring and monitoring relays

		Monitoring voltage per phase	Supply voltage	Part no. Article no.
Insulation monitoring relay 	Insulation resistance in non-earthed AC supply systems	Response value 1-100 kΩ, 250 V AC / 300 V DC	24 - 240 V 50/60Hz AC/DC	EMR6-R250-A-1 184772
		Response value 1-100 kΩ, 400 V AC	24 - 240 V 50/60Hz AC/DC	EMR6-R400-A-1 184773
		1-100 kΩ, 2-200 kΩ, 400 V AC / 600 V DC	24 - 240 V 50/60Hz AC/DC	EMR6-R400-A-2 184774
Temperature monitoring relay 	Extension of the measuring range to 690 V AC and 1000 V DC		---	EMR6-RC690 184775
	Measuring range -50 - +50 °C	PT100 - Sensor	24 - 240 V 50/60 Hz AC/DC	EMR6-T50-A-1 184786
	Measuring range 0 - +100 °C	PT100 - Sensor	24 - 240 V 50/60 Hz AC/DC	EMR6-T100-A-1 184787
	Measuring range 0 - +200 °C	PT100 - Sensor	24 - 240 V 50/60 Hz AC/DC	EMR6-T200-A-1 184788

Accessories

		Part no. Article no.
EMR6	Sealable shroud 22.5 mm	EMR6-PH22 184759
	Sealable shroud 45 mm	EMR6-PH45 184760

Dimensions

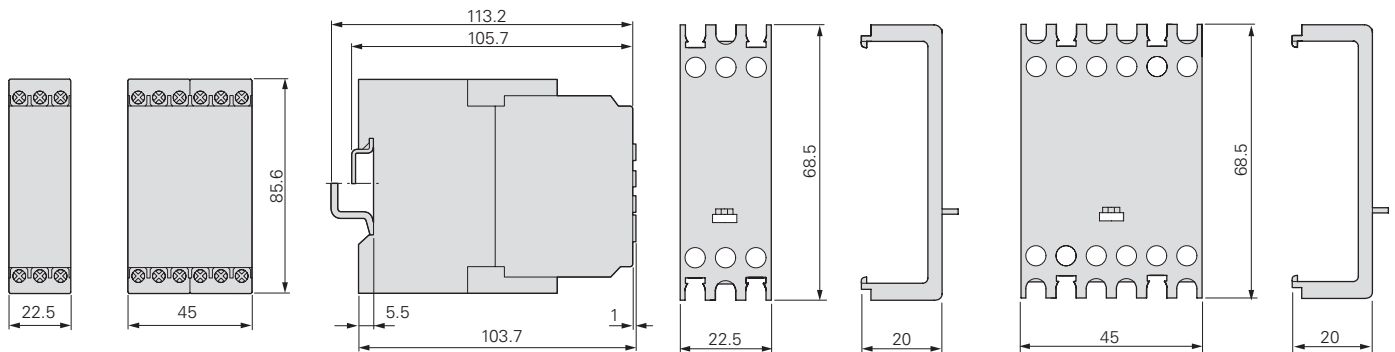

EMT6 thermistor overload relays for machine protection

		Part no. Article no.	
Thermistor overload relays 	Without manual reset, Mains and fault LED display	EMT6 066166	EMT6 (230 V) 066400
	Without manual reset, Mains and fault LED display, With 2 sensor circuits	EMT62 171889	
	Without manual reset, Mains and fault LED display, Trips with short-circuit in the sensor cable	EMT6-K 269470	
	Selector switch with/without manual reset, for manual or remote resetting, Test button, Mains and fault LED display	EMT6-DB 066167	EMT6-DB (230 V) 066401
	Selector switch with/without manual reset, for manual or remote resetting, Test button, Mains and fault LED display, with 2 sensor circuits	EMT62-DB 171890	
	Selector switch with/without manual reset, for manual or remote resetting, Test button, Mains and fault LED display, Trip with short-circuit in the sensor cable	EMT6-KDB 269471	
	Multifunction device, selector switch with/without manual reset, for manual or remote resetting, test button, Mains and fault LED display, Trip with short-circuit in the sensor cable, zero-voltage safe, short-circuit recognition and zero-voltage safety can be deactivated	EMT6-DBK 066168	



Accessories

		Part no. Article no.	
EMT6	Screw adapter for screw fastening	CS-TE 095853	
	Documentation: Overload monitoring of machines in EX e-area	MN03407006Z-DE/EN 151983	

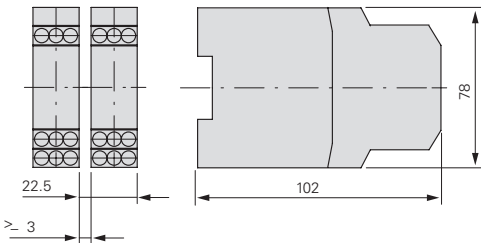
Dimensions



ETR Timing relay

Funktion	On-delayed	Multi-functional	Off-delayed	Fleeting contact on energization	Fleeting contact on de-energization	Flashing, pulse initiating	On- and Off-delayed	Pulse forming	Pulse generating	Star-delta switching	Flashing, pause initiating	Time range	Number of change-over contacts	Part no. Article no.		
														24 - 240 V 50/60 Hz AC/DC	400 V 50/60 Hz AC	
ETR4 	Changeover contact with a changeover time of 50 ms	-	-	-	-	-	-	-	-	X	-	3 - 60 s	1	ETR4-51-A 031884	ETR4-51-W 031885	
	Fixed timing function	X	-	-	-	-	-	-	-	-	-	0.05 s - 100 h	1	ETR4-11-A 031882	ETR4-11-W 031883	
	Adjustable timing functions	X	X	X	X	X	X	X	X	X	-	0.05 s - 100 h	1	ETR4-69-A 031891	ETR4-69-W 031887	
	With connection of potentiometer, Changeover contact can be converted	X	X	X	X	X	X	X	X	X	-	0.05 s - 100 h	2	ETR4-70-A 031888		
														12 - 240 V	24 - 240 V	
50/60 Hz AC/DC																
ETR2  	Fixed timing function	X	-	-	-	-	-	-	-	-	-	0.05 s - 100 h	1		ETR2-11 262684	
	Fixed timing function	X	-	-	-	-	-	-	-	-	-	0.05 s - 100 h	2		ETR2-11-D 119426	
	Fixed timing function	-	-	X	-	-	-	-	-	-	-	0.05 s - 100 h	1		ETR2-12 262686	
	Fixed timing function	-	-	X	-	-	-	-	-	-	-	0.05 s - 100 h	2		ETR2-12-D 119427	
	Fixed timing function	-	-	-	X	-	-	-	-	-	-	0.05 s - 100 h	1		ETR2-21 262687	
	Fixed timing function	-	-	-	-	-	X	-	-	-	-	0.05 s - 100 h	1		ETR2-42 262688	
	Pulse and pause times independently	-	-	-	-	-	X	-	-	-	-	X	0.05 s - 100 h	1		ETR2-44 262730
	Adjustable timing functions	X	X	X	X	X	X	-	X	-	-	X	0.05 s - 100 h	1		ETR2-69 262689
	Adjustable timing functions	X	X	X	X	X	X	-	X	-	-	X	0.05 s - 100 h	2	ETR2-69-D 119428	

Dimensions

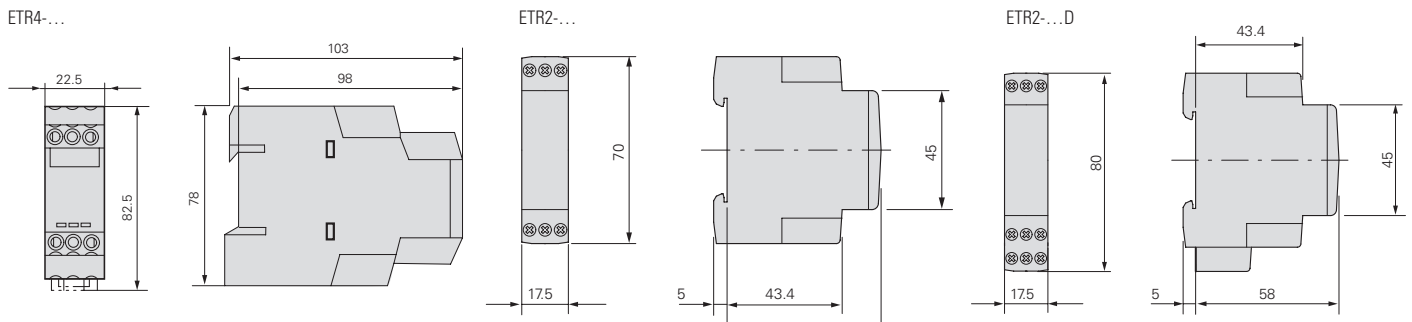

Technical Data EMR6 Measuring and monitoring relays

Measuring and monitoring relays	EMR6-I	EMR6-V	EMR6-N	EMR6-R	EMR6-A	EMR6-F	EMR6-W	EMR6-T
Standards	IEC/EN 60255-6, EN 61557, UL 508, CAN/CSA C22.2 No. 14, CCC, EAC, DNV GL, RCM							
Ambient temperature								
Operating temperatur	-25 - +60 °C							-40 - +60 °C
Storage temperatur	-40 - +85 °C							
Mounting position	as required							
Shock resistance	Class 2							
Degree of protection								
Terminals	IP20							
Housing	IP50							
Terminal capacities								
Solid	1 x 0.5 - 2.5 mm ² (1 x 18 - 14 AWG)							
Flexible with ferrule	2 x 0.5 - 1.5 mm ² (2 x 18 - 16 AWG)							
Pick-up voltage	0.6 - 0.8 Nm							
Rated impulse withstand voltage	4000 V AC							
Overvoltage category/ pollution degree	III/3							
Voltage tolerance	0.85 - 1.1 x U _c							
Duty factor	100 % DF							
Lifespan								
Electrical	0.1 x 10 ⁶ Operations							
Mechanical	30 x 10 ⁶ Operations							
Power consumption	2.6 VA	2.6 VA	2.6 VA	3.5 VA	Datasheet	11 VA	10 / 18 VA	2.9 VA
Rated operational current	250 V AC	250 V AC	250 V AC	250 V AC / 300 V DC	250 V AC	250 V AC	250 V AC	250 V AC / 300 V DC
On-delay	IF 0; 0.1 - 30 s IM 0; 0.1 - 30 s	VF 0; 0.1 - 30 s VM 0; 0.1 - 30 s	---	---	0.2 s	---	0.2 s	---
Off-delay	I 0; 0.1 - 30 s IF 0; 0.1 - 30 s IM 0; 0.1 - 30 s	---	---	---	0; 0.1 - 30 s	---	0; 0.1 - 30 s	---
Monitoring / Measuring	..1.. 0 - 0.03 A 0.01 - 0.1 A 0.1 - 1 A ..15.. 0.3 - 1.5 A 1 - 5 A 3 - 15 A	3 - 30 V 6 - 60 V 30 - 300 V 60 - 600 V	...100... 5 - 100 kΩ ...1000... 0.1 - 1000 kΩ	...A-1 1 - 100 kΩ ...A-2 1 - 100 kΩ 2 - 200 kΩ	90 - 170 V 180 - 280 V 300 - 500 V 350 - 580 V 450 - 720 V 530 - 820 V	200 - 500 V AC	...-W300 160 - 300 V ...-W500 300 - 500 V ...-W380 380 V ...-W400 400 V	...-T50 -50 - +50 °C ...-T100 0 - +100 °C ...-T200 0 - +200 °C
Measuring sensor			B1 - Reference B2 - Maximum B3 - Minimal					Pt 100
Hysteresis	I 3 - 30 % IF 5 % IM 3 - 30 %	VM 3 - 30 % VF 5 %	---	25 %	A 20 % AW 5/20 % AWM 5/20 % AWN 5/20 %	---	5 %	2 - 20 %
Dimensions (Width x Height x Depth)	22.5 x 85.6 x 103.7 mm	22.5 x 85.6 x 103.7 mm	22.5 x 85.6 x 103.7 mm	...-A-1 22.5 x 85.6 x 103.7 mm ...-A-2 / RC 45 x 85.6 x 103.7 mm	...-A / AW 22.5 x 85.6 x 103.7 mm ...-AWM 45 x 85.6 x 103.7 mm	22.5 x 85.6 x 103.7 mm	22.5 x 85.6 x 103.7 mm	22.5 x 85.6 x 103.7 mm
Weight	0.152 kg	0.155 kg	0.14 - 0.15 kg	0.14 - 0.24 kg	0.13 - 0.23 kg	0.128 kg	0.139 kg	0.151 kg
Status-LEDs	I (red) - Failure R (yellow) - Relay status U/T (green) - Supply voltage.	U (red) - Failure R (yellow) - Relay status U/T (green) - Supply voltage.	Min/max (green) - Min + Max wetted R (yellow) - Relay status U (green) - Supply voltage.	F (red) - Failure R (yellow) - No Failure U (green) - Supply voltage.	Pleasee see IL's	F (yellow) - Relay status R (red) - Failure	R/T (yellow) - Relay status F1/F2 (red) - Failure	T (red) - Failure R (yellow) - Relay status U (green) - Supply voltage.
Electromagnetic compatibility								
Interference immunity	EC/EN 61000-6-2							
Electrostatic discharge IEC/EN 61000-4-2	Level 3 (6 kV / 8 kV)							
Electromagnetic fields IEC/EN 61000-4-3	Level 3 (10 V/m)							
Fast transients (Burst) IEC/EN 61000-4-4	Level 3 (2 kV / 2 kHz)							
Power pulses (Surge) IEC/EN 61000-4-5	Level 3 (2 kV)							
Cable-borne HF IEC/EN 61000-4-6	Level 3 (10 V)							
Interference emission	Class 3							
Electromagnetic fields	IEC/EN 61000-6-3							
IEC/CISPR 22, EN 55022	Class B							
Cable-borne HF IEC/CISPR 22, EN 55022	Class B							

Technical Data EMT6 thermistor overload relays for machine protection

Thermistor overload relays for machine protection

EMT6

General	
Standards and Climatic proofing	IEC/EN 60947, VDE 0660, EN 55011
	Damp heat, constant, to IEC 60068-2-78; Damp heat, cyclic, to IEC 60068-2-30
Ambient temperature	
Open	-25 - +60 °C
Enclosed	-25 - +45 °C
Storage	-45 - +60 °C
Mounting position	as required
Weight	0.15 kg
Mechanical shock resistance half-sinusoidal shock 10 ms to IEC 60068-2-27	10 g
Protection against direct contact when actuated from front (EN 50274)	IP20, Finger and back-of-hand proof
Safe isolation to EN 61140	
Between the contacts	250 V AC
Between contacts and power supply	250 V AC
Auxiliary and control circuits	
Rated impulse withstand voltage	6000 V AC
Overvoltage category/pollution degree	III/3
Terminal capacities Auxiliary and control circuits	
Solid	1 x 2.5 mm ² 2 x (0.5 - 1.5) mm ²
Flexible with ferrule	1 x 2.5 mm ² 2 x (0.5 - 1.5) mm ²
Solid or stranded	20 - 14 AWG
Terminal screw	M3.5
Tightening torque	1.2 Nm
Tools	
Pozidriv screwdriver	Size 2
Standard screwdriver	1 x 6 mm
Auxiliary power circuit	
Rated insulation voltage	400 V
Rated operational current	
AC-14, N/O, 415 V le	3 A
AC-14, N/C, 415 V le	3 A
AC-15, N/O, 240 V le	3 A
AC-15, N/O, 415 V le	1 A
AC-15, N/C, 415 V le	3 A
AC-15, N/C, 240 V le	1 A
Max. short-circuit protective device	
Fuse gG/gL	6 A
Control circuit	
Rated insulation voltage	240 V
Rated operational voltage	240 V (EMT6(-DB)230V: U _e = 230 V)
Pick-up and drop-out values	0.85 - 1.1 x U _c
Power consumption	
AC	3.5 VA
DC	2 W
Trip at approx.	≥3600 Ω
Recovery at approx.	≤1600 Ω

Technical Data ETR Timing Relay

Timing relay	ETR4-A	ETR4-W	ETR2-11 (12, 21, 42, 44, 69)	ETR2-69-D	ETR2-11-D / ETR2-12-D
General					
Standards	IEC/EN 61812 VDE 0435	IEC/EN 61812 VDE 0435	IEC 61812-1, EN 61812-1 + A11, DIN VDE 0435 Teil 2021		
Lifespan, mechanical	30 x 10 ⁶	30 x 10 ⁶	30 x 10 ⁶	30 x 10 ⁶	30 x 10 ⁶
Lifespan, electrical	0.1 x 10 ⁶	0.1 x 10 ⁶	0.1 x 10 ⁶	0.1 x 10 ⁶	0.1 x 10 ⁶
Climatic proofing	Damp heat, constant, to IEC 60068-2-78; Damp heat, cyclic, to IEC 60068-2-30				
Ambient temperature					
Ambient temperature, storage	-45 - +60 °C	-45 - +60 °C	-40 - +85 °C	-40 - +85 °C	-40 - +85 °C
Open	-25 - +60 °C	-25 - +60 °C	-20 - +60 °C	-20 - +60 °C	-20 - +60 °C
Enclosed	-25 - +45 °C	-25 - +45 °C			
Mounting position	as required	as required	as required	as required	as required
Mechanical shock resistance (IEC/EN 60068-2-27) Half-sinusoidal shock, 20 ms Make contact	4 g	4 g	10 g	10 g	10 g
Degree of protection Terminals	IP20	IP20	IP20	IP20	IP20
Weight	0.1 kg	0.1 kg	0.06 kg	0.065 kg	0.065 kg
Terminal capacities					
Solid	1 x (0.75 - 2.5) mm ²	1 x (0.75 - 2.5) mm ²	1 x (0.5 - 2.5) mm ²	1 x (0.5 - 2.5) mm ²	1 x (0.5 - 2.5) mm ²
	2 x (0.75 - 1.5) mm ²	2 x (0.75 - 1.5) mm ²	2 x (0.5 - 1.5) mm ²	3 x (0.5 - 1.5) mm ²	4 x (0.5 - 1.5) mm ²
Flexible with ferrule	1 x (0.75 - 2.5) mm ²	1 x (0.75 - 2.5) mm ²	1 x (0.5 - 4) mm ²	1 x (0.5 - 4) mm ²	1 x (0.5 - 4) mm ²
	2 x (0.75 - 1.5) mm ²	2 x (0.75 - 1.5) mm ²	2 x (0.5 - 1.5) mm ²	2 x (0.5 - 1.5) mm ²	2 x (0.5 - 1.5) mm ²
Solid or stranded	1 x (20 - 14) AWG	1 x (20 - 14) AWG	2 x (20 - 14) AWG	2 x (20 - 14) AWG	2 x (20 - 14) AWG
Contacts					
Rated impulse withstand voltage Uimp	6000 V AC	6000 V AC	4000 V AC; 12/15 µs	4000 V AC; 12/15 µs	4000 V AC; 12/15 µs
Overvoltage category/pollution degree	III/2	III/2	III/3	III/3	III/3
Rated insulation voltage Ui	600 V AC	600 V AC	300 V AC	300 V AC	300 V AC
Rated operational voltage Ue	440 V AC	440 V AC	300 V AC	300 V AC	300 V AC
Safe isolation to EN 61140					
Between coil and auxiliary contacts	250 V AC	250 V AC	250 V AC	250 V AC	250 V AC
Between the auxiliary contacts	250 V AC	250 V AC	250 V AC	250 V AC	250 V AC
Making capacity					
AC-14 cos φ = 0.3 440 V	48 A	48 A			
AC-15 cos φ = 0.3 220 V	50 A	50 A			
DC-11 L/R ≤ 40 ms	1.1 x Ie	1.1 x Ie			
Breaking capacity					
AC-14 cos φ = 0.3 440 V	3 A	3 A			
AC-15 cos φ = 0.3 220 V	3 A	3 A			
DC-11 L/R ≤ 40 ms	1.1 x Ie	1.1 x Ie			
Rated operational current					
AC-12 230 V Ie			6 A	5 A	5 A
AC-14 440 V Ie	3 A	3 A			
AC-15 220 V (230 V) N/O Ie	3 A	3 A	3 A	3 A	3 A
AC-15 220 V (230 V) N/C Ie	3 A	3 A	3 A	0.75 A	0.75 A
(DC-111) L/R max. 15 ms, 24 V Ie	1.5 A	1.5 A			
L/R max. 50 ms Ie	1.2 A	1.2 A			
DC12 24 V			6 A	5 A	5 A
DC13 24 V N/O			2 A	3 A	3 A
DC13 24 V N/C			2 A	1 A	1 A
Conv. thermal current Ith	6 A	6 A	5 A	5 A	5 A
AC-operated	250 V	250 V	300 V	300 V	300 V
	6 A	6 A	5 A	5 A	5 A
Pilot Duty / AC-operated	B300	B300	B300	B300	B300

Timing relay	ETR4-A	ETR4-W	ETR2-11 (12, 21, 42, 44, 69)	ETR2-69-D	ETR2-11-D / ETR2-12-D
Short-circuit rating without welding 2)					
Max. fuse, make contacts	6 A gG/gL	6 A gG/gL	10 A gG/gL	10 A gG/gL	10 A gG/gL
Max. fuse, break contacts	6 A gG/gL	6 A gG/gL	6 A gG/gL	6 A gG/gL	6 A gG/gL
Max. overcurrent protective device, 220/230 V	FAZ-B4/1-HI	FAZ-B4/1-HI			
Magnet systems					
Rated operational voltage					
AC	24 - 240	400	24 - 240	12 - 240	24 - 240
DC	24 - 240	-	24 - 48	12 - 240	24 - 48
Rated frequency					
AC-operated	47 - 63 Hz	47 - 63 Hz	DC / 47 - 63 Hz	DC / 47 - 63 Hz	DC / 47 - 63 Hz
DC-operated	0.85 - 1.1 x Uc	0.85 - 1.1 x Uc	0.85 - 1.1 x Uc	0.85 - 1.1 x Uc	0.85 - 1.1 x Uc
DC-operated	0.7 - 1.1 x Uc	-			
Power consumption					
Pick-up AC	2 VA	0.5 VA	1.3 VA	6.25 mA	31.3 mA
Sealing AC	2 VA	0.5 VA	1.3 VA	6.25 mA	31.3 mA
Pick-up DC	1.8 W	-	0.6 W		24.1 mA
Sealing DC	1.8 W	-	0.6 W		24.1 mA
Duty factor	100 % DF	100 % DF	100 % DF	100 % DF	100 % DF
Maximum operating frequency	4000 Ops/h	4000 Ops/h			
Minimum command time					
AC	50 ms	50 ms	30 ms	30 ms	30 ms
DC	30 ms	-	30 ms	30 ms	30 ms
Repetition accuracy (deviation)	≤ 0.5 %	≤ 0.5 %	≤ 0.5 %	≤ 0.5 %	≤ 0.5 %
Recovery time (after 100% time delay)	70 ms	70 ms	< 50 ms	< 50 ms	< 50 ms
Contact changeover time	4 ms	4 ms			
Electromagnetic compatibility (EMC)					
Electrostatic discharge (IEC/EN 61000-4-2, Level 3, ESD)					
Air discharge	8 kV	8 kV			
Contact discharge	6 kV	6 kV			
Electromagnetic fields (IEC/EN 61000-4-3, RFI)					
Radio interference suppression (EN 55011)	10 V/m	10 V/m			
Burst (IEC/EN 61000-4-4, Level 3)	EN 55011 Class A	EN 55011 Class A			
Power pulses (Surge) (IEC/EN 61000-4-5, Level 2)	2	2			
Immunity to line-conducted interference to (IEC/EN 61000-4-6)	1 kV	1 kV			
	10 V	10 V			

At Eaton, we are solution-driven, supplying energy to a world that is ever more demanding. With over 100 years of expertise in the area of power management, we are ready for the future. Core industries all around the globe rely on Eaton and on our pioneering products, total solutions and engineering services.

Companies know they can always trust our reliable, efficient, and safe power management solutions. Together with our personalized service and support, as well as our forward-looking attitude, these solutions meet the needs of tomorrow, today. Follow the charge. Visit **eaton.eu**.