

2/2 ... 4/4 Solenoid Directional Seat Valve, ISO Size 03

$Q_{\max} = 40 \text{ l/min (11 gpm)}$, $p_{\max} = 315 \text{ bar (4500 psi)}$

Bidirectional leak-proof shutoff, direct acting, electrically operated

Series W2N..., W2P...

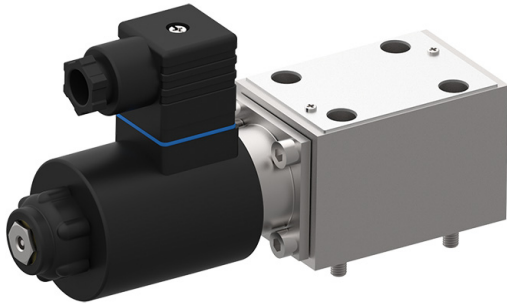

- With cartridge valve, type W1.B...
- Interface to ISO 4401-03-02
- Bidirectional leak-proof shutoff or flow
- Version with closed crossover (overlap)
- With or without manual override
- Hand lever can be fitted on solenoid
- With optional push-in check valve or orifice
- High pressure wet-armature solenoids
- The slip-on coil can be rotated, and it can be replaced without opening the hydraulic envelope

1 Description

The W2N... / W2P... series of 2/2 ... 4/4 solenoid operated directional seat valves are direct acting manifold-mounting valves with a size 03 interface to ISO 4401-03-02. The main components of the valves are a manifold-mounting body and the push-in 2/2 or 3/2 directional seat valve cartridge (type W1...). Dependent on the operating position, the ports are either closed with virtually zero leakage, or open and flow is possible in either direction. The "overlapped" model (W2P...) features a closed crossover characteristic i.e. during the valve's switching period, there is no connection between the ports and therefore only a minimal loss of flow/pressure occurs. These solenoid operated seat valves are also available with or without manual override, and with the

option of an additional hand lever. For applications where a check valve or an orifice in the P port is necessary, either of these features can be included as an option. These solenoid operated seat valves are predominantly used in certain mobile and industrial applications where leak-tight shut-off functions are crucially important. Examples are where loads, tensions, or clamping forces must be held without leakage. The manifold-mounting body is phosphated. All external parts of the cartridge are zinc-nickel plated to DIN 50 979 and are thus suitable for use in the harshest operating environments. The slip-on coils can be replaced without opening the hydraulic envelope and can be positioned at any angle through 360°.

2 Technical data

General characteristics	Description, value, unit	
Designation	2/2, 3/2, 3/3, 4/3 or 4/4 solenoid operated directional seat valve	
Design	manifold-mounting, bidirectional leak-proof shutoff, direct acting poppet and valve-spool design (pressure balanced) with underlapped or overlapped spool	
Mounting method	4 x $\varnothing 5,5$ holes for M5x30 cap screws	
Tightening torque	5.2 Nm $\pm 5\%$ (4 ft-lbs $\pm 5\%$)	
Size	size 03 interface to ISO 4401-03-02 / DIN 24 340 A6	
Weight	1.75 kg (2/2 ... 3/2 models) 2.50 kg (3/3 ... 4/4 models)	
Mounting attitude	unrestricted	
Hydraulic characteristics	Description, value, unit	
Maximum operating pressure	315 bar	(4500 psi)
Maximum flow rate	– W2N – W2P	40 l/min (11 gpm) info will follow
Flow direction	see symbols	

Hydraulic characteristics	Description, value, unit
Hydraulic fluid	HL and HLP mineral oil to DIN 51 524; for other fluids, please contact BUCHER
Ambient temperature range ¹⁾	-25 °C ... +80 °C (-13 °F ... 176 °F)
Hydraulic fluid temperature range	-25 °C ... +80 °C (-13 °F ... 176 °F)
Viscosity range	10...500 mm ² /s (cSt), recommended 15...250 mm ² /s (cSt)
Minimum fluid cleanliness Cleanliness class to ISO 4406 : 1999	class 20/18/15
Electrical characteristics	Description, value, unit
Supply voltage	12 V DC, 24 V DC / 115 V AC, 230 V AC (50 ... 60 Hz) others by consultation
Supply voltage tolerance	± 10 %
Ambient temperature range ¹⁾	-25 °C ... +50 °C (-13 °F ... 122 °F)
Nominal power consumption	V DC = 30...32 W / V AC = 31...32 W
Switching time	refer to cartridge valve - see "Related data sheets"
Relative duty cycle	100 %
Protection class to ISO 20 653 / EN 60 529	IP 65 / IP 67 / IP 69K, see "Ordering code" (with appropriate mating connector and proper fitting and sealing)
Electrical connection	DIN EN 175301-803, 3-pin 2 P+E (standard) for other connectors, see "Ordering code"



IMPORTANT!:

¹⁾ The less favourable values from the hydraulic and electrical characteristics determine the temperature range of the whole valve.



IMPORTANT!

To ensure the performance data is not compromised, it is imperative to use coils D45/207 according to data sheet 400-P-120120.

3 Performance graphs



IMPORTANT!

Detailed performance data and other hydraulic characteristics can be found in the data sheet for the respective 2/2 or 3/2 solenoid operated cartridge seat valve (series W1...) that is fitted. See "Related data sheets".



ATTENTION!

The performance figures in the data sheet for the cartridge valve refer just to the cartridge itself. Take into account the additional pressure drop in the body into which it is fitted.

$\Delta p = f(Q)$ Pressure drop - Flow rate characteristic through orifice (metering function)

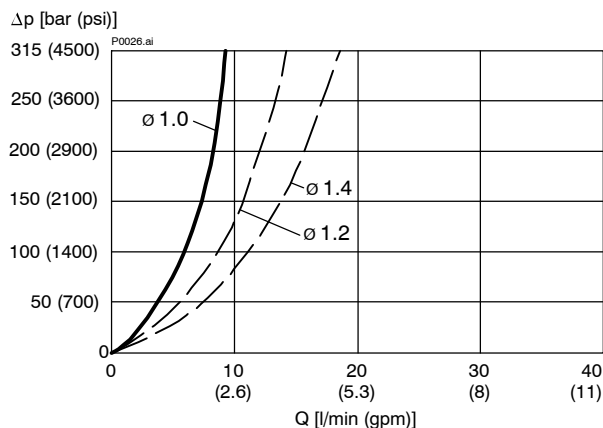

ø 1.2 and ø 1.4 orifices drilled out by customer!

$\Delta p = f(Q)$ Pressure drop - Flow rate characteristic through push-in check valve

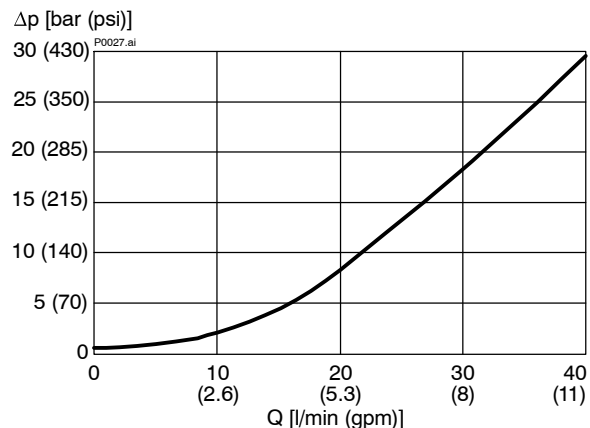

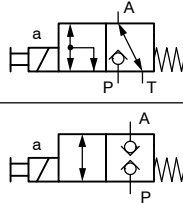
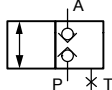
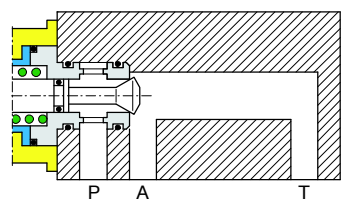
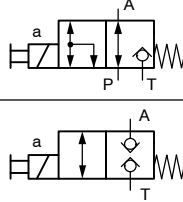
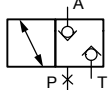
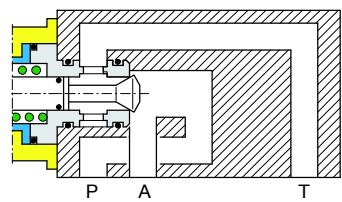
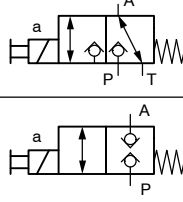
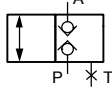
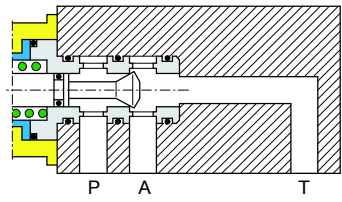
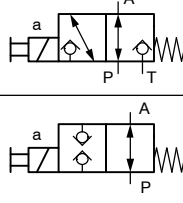
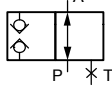
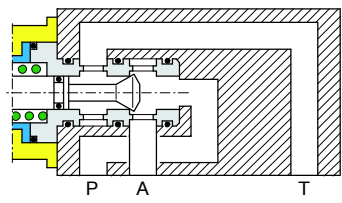
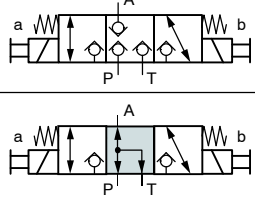
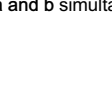
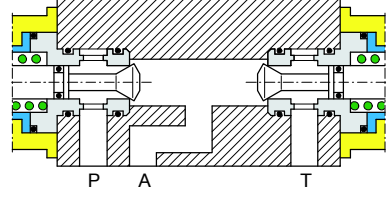
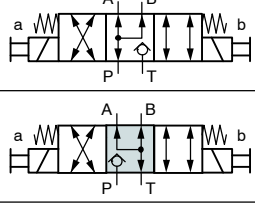
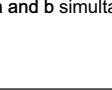
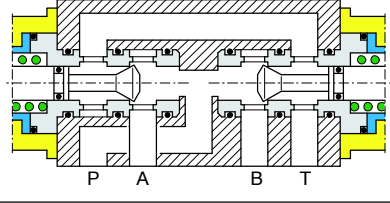
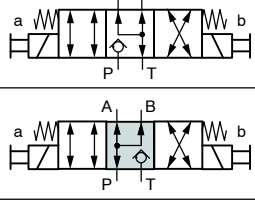
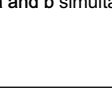
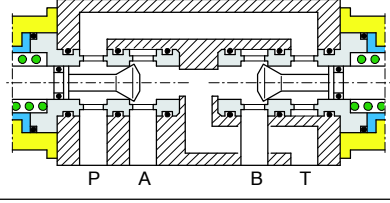
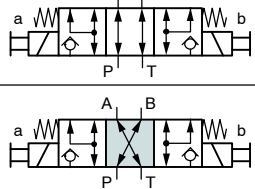
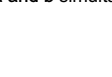
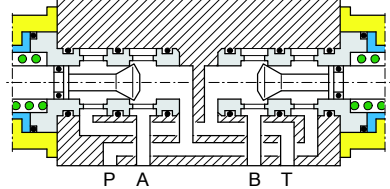
Code	Symbols	Remarks	Operating principle
2-way circuit (with 2/2 cartridge seat valve)	22 S	 <p style="text-align: center;">For 2/2 circuits, the customer must plug the T port!</p> 	
	22 O	 <p style="text-align: center;">For 2/2 circuits, the customer must plug the P port!</p> 	
	32 S	 <p style="text-align: center;">For 2/2 circuits, the customer must plug the T port!</p> 	
	32 O	 <p style="text-align: center;">For 2/2 circuits, the customer must plug the T port!</p> 	
3-way circuit (with 3/2 cartridge seat valve)	33 R	 <p style="text-align: center;">To achieve the 4th valve function (the shaded box), energise the two solenoids a and b simultaneously!</p> 	
	43 F	 <p style="text-align: center;">To achieve the 4th valve function (the shaded box), energise the two solenoids a and b simultaneously!</p> 	
4-way circuit (with 3/2 cartridge seat valves)	43 G	 <p style="text-align: center;">To achieve the 4th valve function (the shaded box), energise the two solenoids a and b simultaneously!</p> 	
	44 A	 <p style="text-align: center;">To achieve the 4th valve function (the shaded box), energise the two solenoids a and b simultaneously!</p> 	

4 Dimensions & sectional view

2/2 and 3/2 solenoid operated directional seat valve (single-solenoid model)

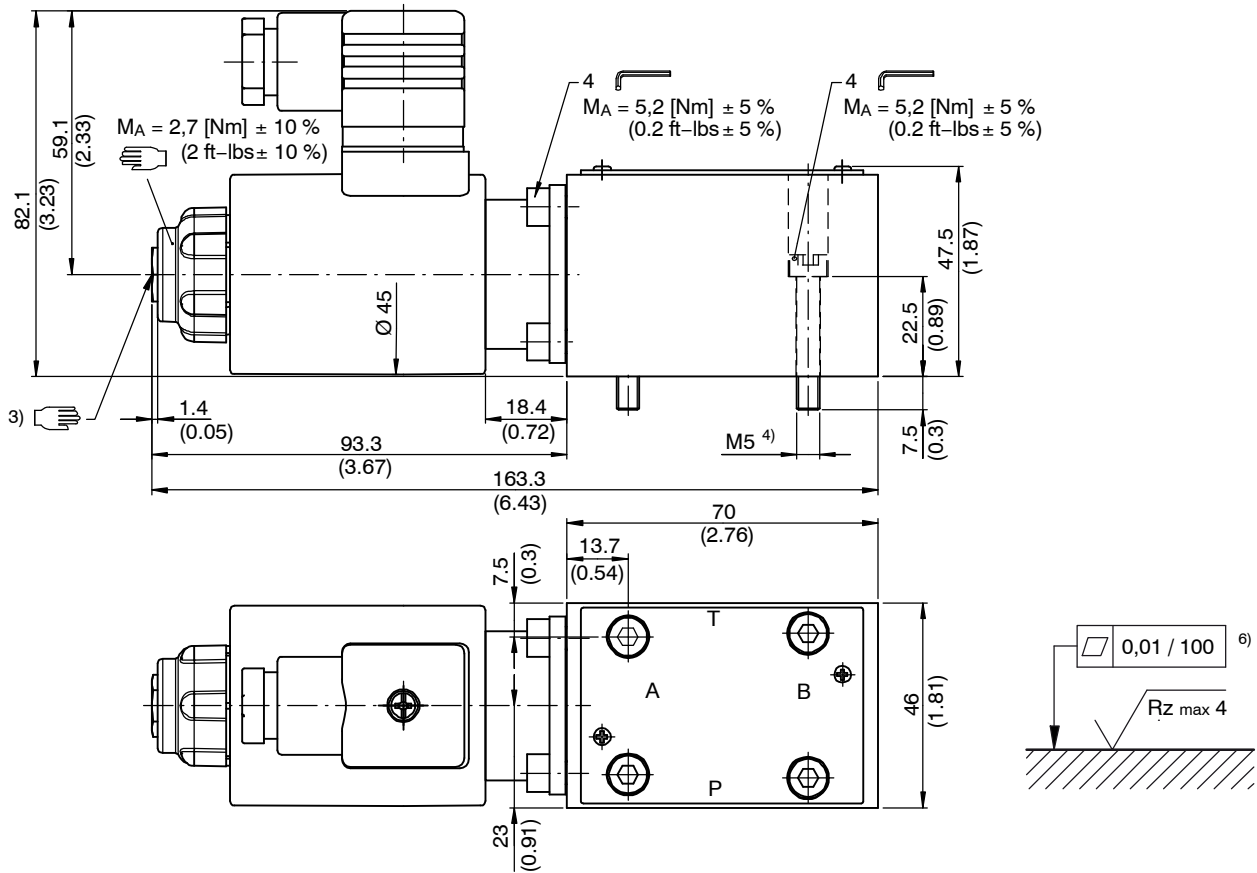

3/3, 4/3, and 4/4 solenoid operated directional seat valve (double-solenoid model)

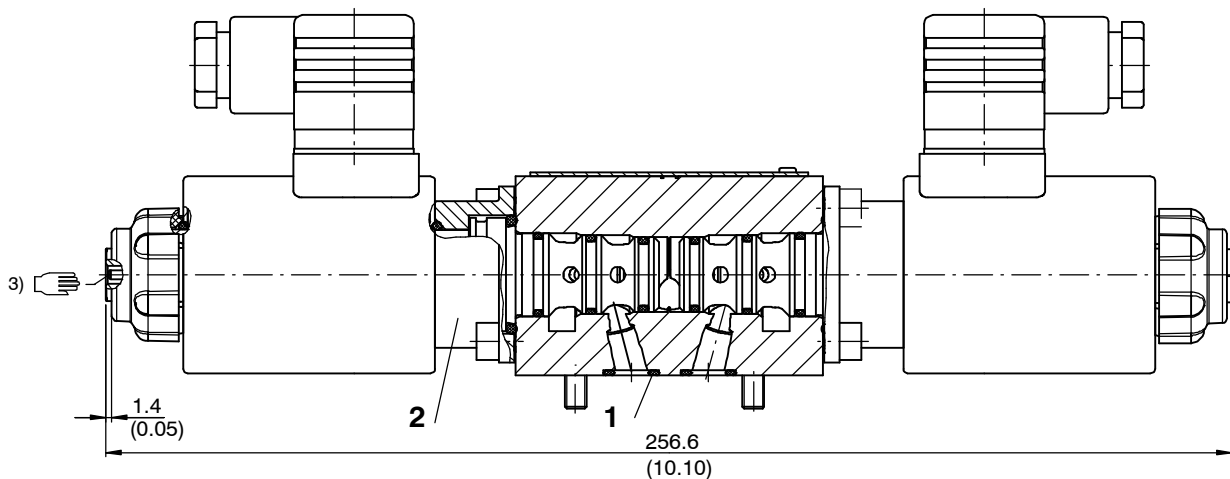

Seal kit no. DS-098-N ⁵⁾

Item	Qty.	Description
1	4	O-ring no. 012 Ø 9,25 x 1,78 N90
2	2	NBR seal kit no. DS-095-N for seat valve, type W1...



IMPORTANT!

- 3) Can be chosen with or without manual override. (see ordering code)
- 4) Valve mounting bolts M5x30 (included in the delivery)
- 5) Seal kit with Viton seals, no. DS-098-V
- 6) Required surface finish on the mounting face (valve pad)



IMPORTANT!

When replacing an old coil with connection according to DIN 43650/ISO4400 (with other Pin set-up than according to datasheet 400-P-120120), the new coil can be mounted in 180° reversed position so that the existing plug (with 180° earthing-PIN) can be connected. This does not affect the performance data.

5 Options

5.1 Hand lever fitted on solenoid

As an option, the W2N... / W2P... series of solenoid operated directional seat valves are available with an additional hand lever. Two models can be supplied; the "HHB" hand lever with detent feature, and the "HHNB" hand lever without detent feature.



IMPORTANT!

Hand levers can only be fitted to valves that have a manual override.

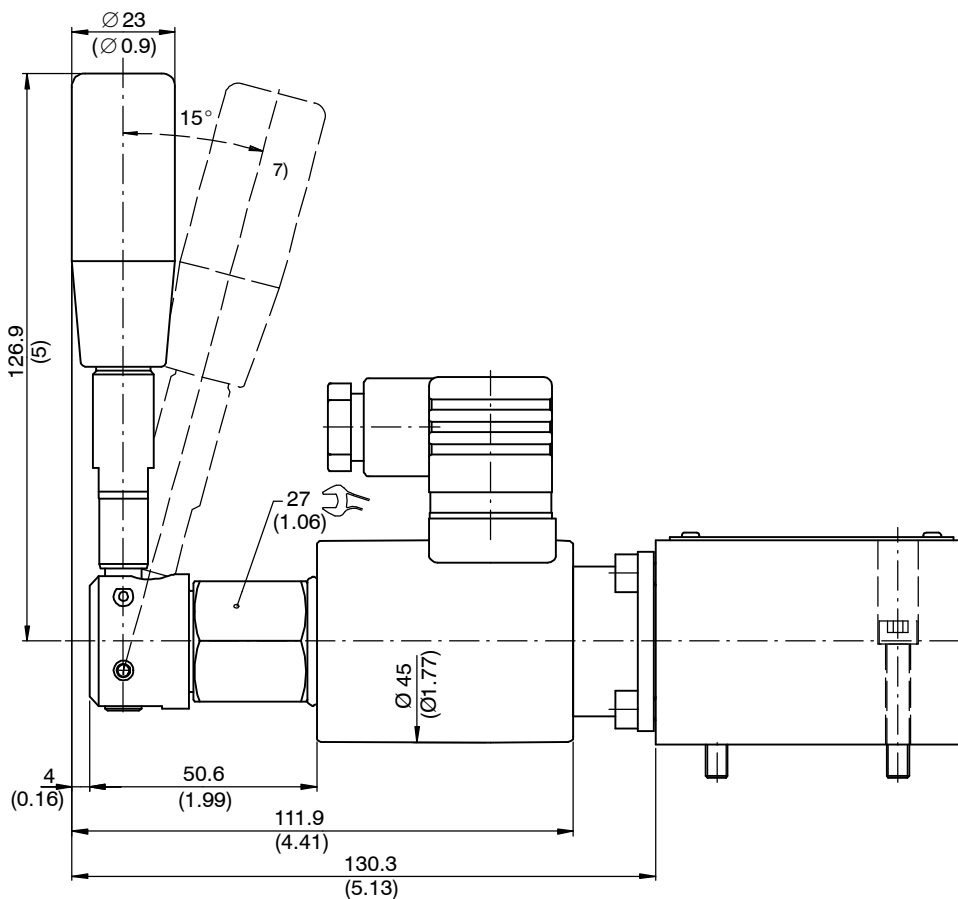

7) Operated position

5.2 Push-in check valve

To prevent uncontrolled back-pressure effects or back-flow of oil, series W2N... / W2P... solenoid operated directional seat valves can be supplied with an optional push-in check valve, type RCA-5, and a special body. The check valve allows free flow from P to A or B, but prevents flow in the opposite direction, with no leakage.

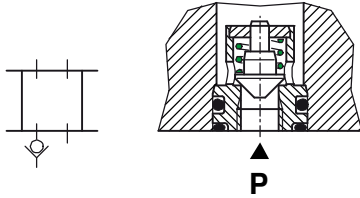

Application: when several valves are supplied in parallel, for instance, and the supply pressure in P drops below the pressure in A or B (another circuit is vented, or a lightly-loaded actuator is operated). The pressure in service line A or B is then higher, but the check valve prevents it from falling during such operations in other circuits.

6 Installation information



ATTENTION!

Only qualified personnel with mechanical skills may carry out any maintenance work. Generally, the only work that should ever be undertaken is to check, and possibly replace, the seals. When changing seals, oil or grease the new seals thoroughly before fitting them.

5.3 Orifice (metering function)

An orifice disc (type D10, \varnothing 1.0 mm) must be used when, as a consequence of the operating conditions that exist, circuit operations may result in flow rates that exceed the performance limit of the valve.



IMPORTANT!

The orifice disc fitted for this purpose is \varnothing 1.0 mm. Customers may drill it out to \varnothing 1.4 mm maximum (see performance graphs).

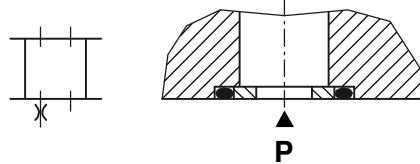

Application: when used for charging accumulators, for instance, or when the solenoid operated directional seat valves are used to pilot other valves.



IMPORTANT!

When fitting the valves, use the specified tightening torque for the mounting bolts. No adjustments are necessary, since the cartridges are set in the factory.

7 Ordering code

Ex.		W2	N	32S	N	6	B	B	-	24	-	-	+ HHB	-
W2	=	solenoid directional seat valve, manifold mtg.												
N	=	open crossover (standard)												
P	=	closed crossover, (only possible with 3/2, 4/3, and 4/4 functions)												
22 S	=	2/2 function, P closed												
22 O	=	2/2 function, P ↔ A connected												
32 S	=	3/2 function, P closed												
32 O	=	3/2 function, P ↔ A connected												
33 R	=	3/3 function, P, A and T closed												
43 F	=	4/3 function, P ↔ A ↔ B connected												
43 G	=	4/3 function, A ↔ B ↔ T connected												
44 A	=	4/4 function, P ↔ A and B ↔ T connected												
N	=	without push-in check valve or orifice (standard)												
R	=	with push-in check valve, type RCA-5 (in P port)												
D10	=	with orifice disc, type D10 (in P port)												
6	=	ISO size 03 interface												
B ... Q	=	standard model - see relevant data sheets												
Z ... R	=	special features - please consult BUCHER												
Nitrile seals														
Viton seals														
B G	=	with manual override												
D I	=	without manual override												
1 ... 9	=	design number, seat valve (omit when ordering new units)												
...	=	voltage e.g. 24 (24 V)												
D	=	current DC												
A	=	current AC (connection only possible with DIN EN 175301-803)												
(blank)	=	DIN EN 175301-803 connection with mating plug (standard, IP 65)												
M100	=	DIN EN 175301-803 connection without mating plug												
		<i>for the following plug-variants [mating plug not supplied]:</i>												
DT	=	Deutsch plug connection DT04-2P (with quenching diode, IP 67/69K)											} <i>consult Bucher</i>	
JT	=	Junior Timer radial plug connection (with quenching diode, IP 65)												
F	=	flying leads (600mm) (IP 65)												
without	=	without hand lever (standard)												
+ HHB	=	with hand lever with detent												
+ HHNB	=	with hand lever without detent												
1 ... 9	=	design number, hand lever (omit when ordering new units)												

8 Related data sheets

Reference	(Old no.)	Description
400-P-030501	(i-31)	Size 03 interface to ISO 4401-03-02
400-P-120120		Solenoid coil, series D45/207
400-P-110111		2/2 solenoid cartridge valve, type W1C.B... size 6
400-P-110116		3/2 solenoid cartridge valve, type W1D.B.../ W1F.B... size 6

info.ch@bucherhydraulics.com

www.bucherhydraulics.com

© 2017 by Bucher Hydraulics AG Frutigen, CH-3714 Frutigen

All rights reserved.

Data is provided for the purpose of product description only, and must not be construed as warranted characteristics in the legal sense. The information does not relieve users from the duty of conducting their own evaluations and tests. Because the products are subject to continual improvement, we reserve the right to amend the product specifications contained in this catalogue.

Classification: 430.300.-.315.315.300 (W-2.13)